

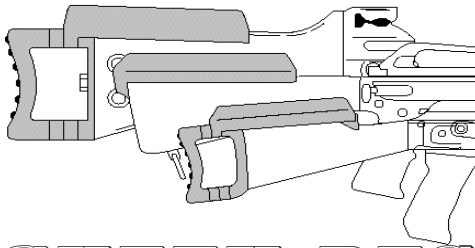

E&L

MANUFACTURING, INC.

A GROWING COMPANY OF QUALITY ACCESSORIES FOR POPULAR WEAPONS



CHEEK RESTS & STOCK EXTENSIONS



BRASS CATCHERS

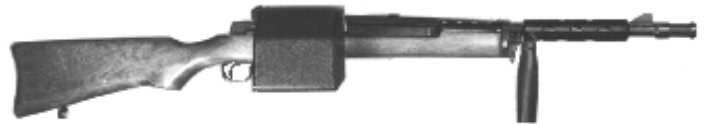
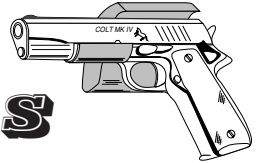

BARREL SHROUDS

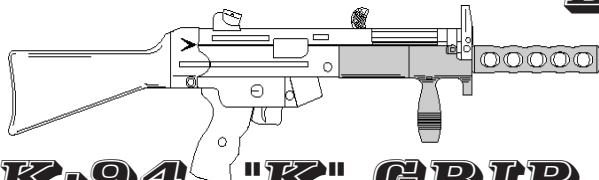

HK-94 "K" GRIP & ADAPTER

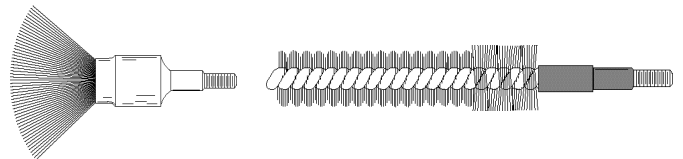

CHAMBER FACE & RECEIVER BRUSH



HK-94 SD SHROUD

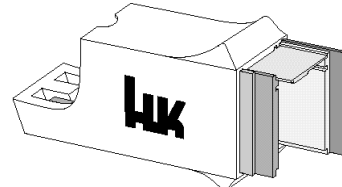

HK MULT-LOADER+



SLIP-ON RECOIL PADS

AMERICAN 180

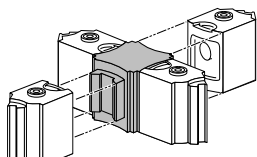
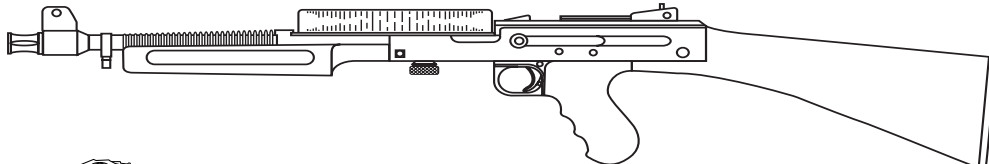

QUAD-CLIP HOLDER



10/22 ACCESSORIES

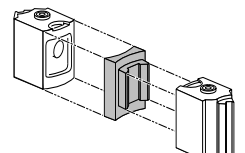

DUAL-CLIP HOLDER



SNAP-ON STYLE RIGID BRASS CATCHERS



CUSTOM MANUFACTURED
IN AMERICA

IN USE BY THE U.S. MILITARY

RIGID BRASS CATCHERS are uniquely designed to conform to the configuration of each weapon and snap on and off instantly. The old style swinging bag has been replaced by a solidly constructed unit of strong, lightweight, black textured plastic, resulting in a brass catcher that is totally efficient and actually compliments the appearance of the weapon. Each unit holds a minimum of 60 rounds (Colt .45 Auto holds 20 rounds, shotgun catchers hold a maximum of 5 rounds) and will not interfere with any moving part of the weapon. RIGID BRASS CATCHERS are a pleasant way to save time and money and will also increase the safety factor for the left-handed shooter.

Standard Snap-on Brass Catchers \$43.95 ea.

Special Item #131* \$79.95

| ORDER # | MODEL | ORDER # | MODEL |
|---------|--|---------|--|
| 101 | MINI-14 | 123 | COLT .45 AUTO/Delta Elite 10mm & Gold Cup (Fits All 1911 Type Frames Holds 20 Rounds .45) |
| 102 | MINI-14 RANCH & MINI-30 | 124 | INTERDYNAMIC KG-9 / KG99 / TEC-9 / etc. |
| 102A | MINI-14 / 5RP (No Side Stock Screws) | 125 | MARLIN .45 & 9mm CAMP CARBINE |
| 103 | AR-15/M-16 (.223 & 7.62 X 39mm) (Also Fits Sporter Match HBAR) | 126 | RUGER 10/22 & .44 MAG. CARBINE |
| 103A | 9mm Sporter Lightweight | 127 | DAEWOO MAX-2/AR-100 & DR-200 |
| 103B | Sporter HBAR "Flat top" (Removable Handle) (Fits With Or Without Handle Attached) | 128 | SKS |
| 104 | H&K-91/SR-9/HK-93 | 129 | AR 180/18 |
| 105 | H&K-94/MP-5/SP-89 | 130 | FEATHER AT-9 & SWEDISH- K |
| 106 | UZI CARBINE 9mm & .45 | 131* | M-60 (Holds a Minimum of 100 Cases & Links) |
| 107 | UZI PISTOL & Mini UZI ect. | 132R | BERETTA STORM (Right Hand) |
| 108 | .30 CARBINE | 132L | BERETTA STORM (Left Hand) <i>If your Beretta Storm has a Picatinny Rail, you will need to order our Universal Catcher Item #U-107</i> |
| 109 | MAC-10/MAC-10A1 (COBRAY) | 133 | M1 Garand |
| 110 | MAC-11 .380 (COBRAY) | 134 | REMINGTON 4 & 74 |
| 111 | MAC-11/9mm (COBRAY) | 135 | MOSSBERG 590 SHOTGUN |
| 112 | STERLING & STEN MKII | 136 | REMINGTON 1100 & 870 SHOTGUN |
| 113 | LINDA (Wilkinson) | 137 | S & W 1000 SHOTGUN |
| 114 | RUGER "P" Police Series Carbines | 138 | M3 / M3A1 "Grease Gun" |
| 115 | H & R Reising | 139 | MUZZELITE MINI-14 BULPUP STOCKS |
| 116 | SMITH & WESSON 76, MK-760 | 140 | H&K SL8 |
| 117 | AKM/AK-47/AKS/VALMET /MAK 90/NHM90 | 141 | H&K USC |
| 118 | THOMPSON 1927 (Top Cocking) | 142 | BENELLI M1 SUPER 90 SHOTGUN |
| 119 | FN-FNC | 143 | KEL-TEC SUB 2000 (Gen. 1&2) |
| 120 | FN-FAL & SAR 48/L1A1 | 144 | KEL-TEC P50 PISTOL 5.7x28 |
| 121 | M-1A/M14 | 145 | American 180 (Full Auto Or Semi) Holds 300 Rounds of .22 LR |
| 122 | STEYR AUG | | |





E & L MFG. INC.

UNIVERSAL RIGID BRASS CATCHERS FITS PICATINNY SCOPE RAILS

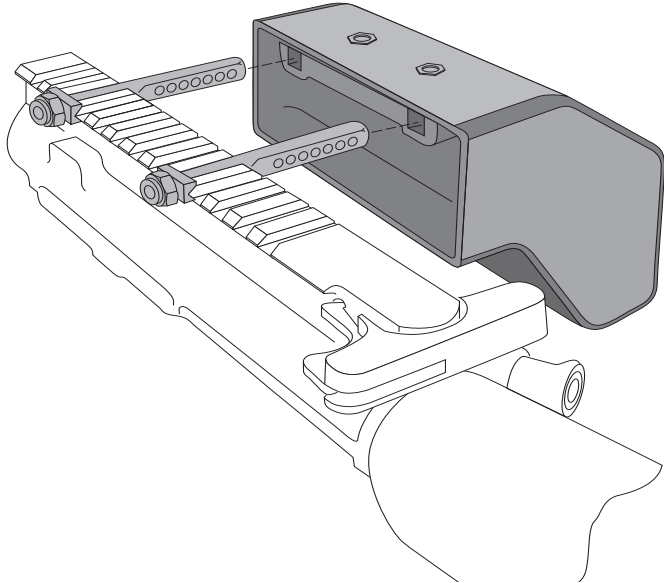

**Universal Brass Catchers Will Fit Most Flat-Top Receivers
That Have A Picatinny Rail Located Above The Exit Port
All Universal Catchers Are Ambidextrous**

U-000 ROD SET (Extra Rod Set For Additional Firearm) _____ \$26.95
Use the same catcher box on additional firearms. (Works with all Universal Catchers)

U-101 UNIVERSAL .223 (Includes Mounting Rods) Will Hold 100 .223 _____ \$64.95

U-102 UNIVERSAL .308 (Includes Mounting Rods) Will Hold 80 .308 _____ \$64.95
(Items U101 & U102 can be ordered with 11 or 12 rod spacing)
7 rod spacing is standard, if 11 or 12 spacing is required, specify
by adding /11 or /12 after the item number. Example U101/11 or U101/12

U-103 UNIVERSAL COMPACT (Includes Mounting Rods) _____ \$54.95
Smaller than U-101 - Made For Sub Guns - Holds 60 rounds of .45, 70 rounds of 9mm or 40 rounds of .223

**U-104 UNIVERSAL MINI-COMPACT (Includes Mounting Rods) Smaller than U-103
Recommended For .22 to .45 Calibers _____ \$54.95**

**U-105 UNIVERSAL ULTRA-COMPACT (Includes Mounting Rods) Smaller Than U-104
Recommended For .22 to .380 Calibers _____ \$54.95**

U-106 UNIVERSAL RUGER PC CARBINS (Includes Mounting Rods) _____ \$54.95

U-107 BERETTA STORM (Includes Mounting Rods) _____ \$54.95
This Catcher Is Made To Fit The Beretta Storm With A Picatinny Rail.

Brass Catcher Sizes = Height & Width

U-101 4 1/2" x 5 1/2" •• U-102 4 1/2" x 6 1/4" •• U-103 4 1/2" x 4 1/2" •• U-104 4" x 3 3/8" •• U-105 3 1/2" x 3 1/4"

ALL E&L PRODUCTS ON THIS PAGE ARE UNCONDITIONALLY GUARANTEED & MADE IN U.S.A.



E & L MFG. INC.

HK-94 SD BARREL SHROUD

Uniquely designed for the HK-94 to give the appearance of the famous HK MP-5 silenced 9mm submachine gun.

A "must have" item for the serious collector and also an excellent HK accessory.

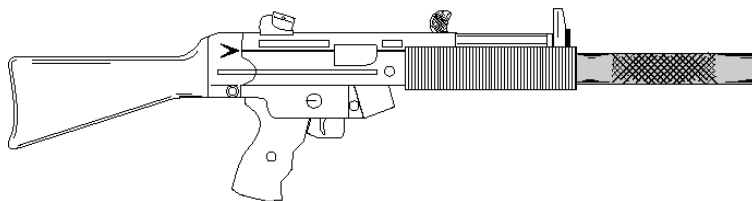

Now available for the **MKE AT-94 A2**

NEW With New Standard Heavy Barrel

NEW

| ORDER # | PRICE | ITEM / MODEL |
|---------|---------|---|
| 310 | \$46.95 | H K-94 SD BARREL SHROUD |
| 311 | \$46.95 | SW.45 SD BARREL SHROUD (Standard Barrel Only) |
| 312 | \$46.95 | SW-5 & BW-5 & Clones (Specify Make & Model) |
| 313 | \$69.95 | GSG-5 .22 Carbine (Special - Custom Made) |
| 314 | \$46.95 | MKE AT-94 18mm Heavy Barrel |

HK-94 "K" GRIP ADAPTER WITH HK "K" GRIP

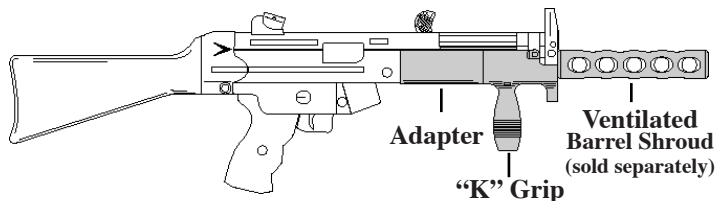

("K" Grip & Adapter shown with Ventilated Shroud Item #205)

The E&L manufactured K GRIP ADAPTER (spacer) enables the user to install the HK manufactured MP-5 K Grip on the HK-94/MP-5. The E&L Adapter is sold as a set with the German manufactured K Grip or the Adapter can be purchased separately for use with the after market "K" Grips.

Caution - Although the HK K Grip can be attached to the SP-89 semi-automatic pistol, the BATF has determined that if the SP-89 pistol is possessed with a forearm having a vertical foregrip such as used on the HK MP-5 submachine gun, the combination would be to create an illegal firearm in violation of Section (e), Chapter 53, Title 26, U.S.C.

| ORDER # | PRICE | ITEM/MODEL |
|---------|---------|---------------------|
| 410 | \$89.95 | K GRIP WITH ADAPTER |
| 411 | \$19.95 | ADAPTER ONLY |

HK MUL-T-LOADER

The HK MUL-T-LOADER+ was designed specifically for HK pistols such as the P7-M13, P7-M8 and P7-K3. Because of the unique design of the MUL-T-LOADER'S removable inserts, a wide variety of other magazines of various calibers can be loaded. With the inserts in various positions, the loader will load a wide variety of 9mm magazines, such as the H&K P7-M8, P7-M13. It will also load the USP40, Beretta-92, Browning High Power, S&W, Taurus and UZI, etc. • .45 caliber magazines such as the Colt .45 Auto as well as the Colt 10mm • .380 caliber magazines such as the H&K P7K3 • .22 caliber magazines such as the Ruger MK 1, 2, etc. • Colt Woodsman and more.

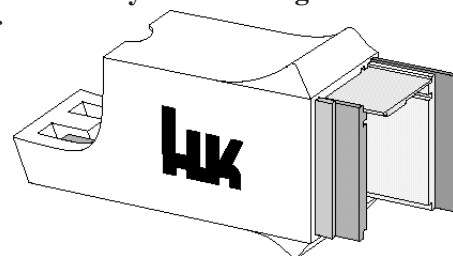

A sturdy black nylon web BELT POUCH with Velcro closure (not pictured) is a convenient way to carry and store your MUL-T-LOADER+

Note: The MUL-T-LOADER+ will not load HK SP-89 magazines.

| ORDER # | PRICE | ITEM/MODEL |
|---------|---------|-----------------------------------|
| 451 | \$19.95 | HK MUL-T-LOADER+ |
| 452 | \$ 5.95 | BELT POUCH (Holds 1 Mul-T-Loader) |

E & L MFG. INC.



BARREL SHROUDS

SOME WITH AMBIDEXTROUS VERTICAL FOREGRIP

THE E & L VENTILATED OR NON-VENTILATED BARREL SHROUD WITH AMBIDEXTROUS FOREGRIP combination for the H&K 94, UZI Carbine, Ruger 10/22, Mini-14, Mini-14 Ranch, Mini-30 and Steyr AUG (Ventilated Barrel Shroud only for Steyr AUG, Mini-14, Ranch and Mini-30) is constructed of aircraft aluminum with a hard black satin finish.

The Ventilated Barrel Shroud features oval shaped openings while the non-ventilated Barrel Shroud gives the appearance of a suppressor-equipped weapon. The Vertical Foregrip is constructed of high impact plastic and can swivel to any desired angle.

The Barrel Shrouds can be attached with or without the Vertical Foregrip and come complete with all necessary hardware.

| ORDER # | PRICE | ITEM/MODEL | DESCRIPTION |
|----------------|---------|------------------------------|--|
| 201 | \$56.95 | MINI-14 & RANCH | Ventilated Barrel Shroud with Foregrip |
| 202 | \$56.95 | UZI Carbine 9mm & .45 | Ventilated Barrel Shroud with Foregrip |
| 203 | \$56.95 | RUGER 10/22 | Ventilated Barrel Shroud with Foregrip |
| 204 | \$56.95 | STEYR AUG | Ventilated Barrel Shroud (NO FOREGRIP) |
| 205 | \$56.95 | H&K 94 | Ventilated Barrel Shroud with Foregrip |
| 205A | \$56.95 | SW-5, BW-5 (H&K Clones) | Ventilated Barrel Shroud with Foregrip |
| 206 | \$56.95 | MINI-30 | Ventilated Barrel Shroud with Foregrip |
| 207 | \$56.95 | H&K USC .45 | Ventilated Barrel Shroud with Foregrip |
| 208 | \$56.95 | UZI SMG (Fits short Barrels) | Ventilated Barrel Shroud (NO FOREGRIP) |
| 209 | \$56.95 | H&K SL8-1 | Ventilated Barrel Shroud (NO FOREGRIP) |
| 210 | \$56.95 | BERETTA CX4 Storm | Ventilated Barrel Shroud with Foregrip |
| NEW 211 | \$56.95 | MKE AT-94 18mm Heavy Barrel | Ventilated Barrel Shroud with Forgrip |
| 302 | \$49.95 | UZI Carbine 9mm & .45 | Non-Ventilated Barrel Shroud with Foregrip |
| 303 | \$49.95 | RUGER 10/22 | Non-Ventilated Barrel Shroud with Foregrip |
| 304 | \$49.95 | H&K 94 | Non-Ventilated Barrel Shroud with Foregrip |
| 304A | \$49.95 | SW-5, BW-5 (H&K Clones) | Non-Ventilated Barrel Shroud with Foregrip |
| 305 | \$49.95 | H&K USC 9mm & .45 | Non-Ventilated Barrel Shroud with Foregrip |
| 306 | \$49.95 | BERETTA CX4 Storm | Non-Ventilated Barrel Shroud with Foregrip |
| 307 | \$49.95 | H&K SL8 | Non-Ventilated Barrel Shroud (NO FOREGRIP) |
| NEW 308 | \$49.95 | MKE AT-94 Heavy Barrel | Non-Ventilated Barrel Shroud with Foregrip |

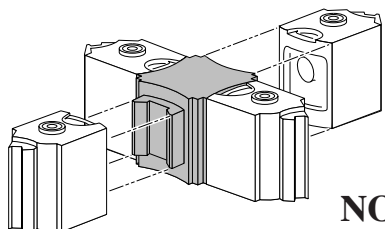

FOR RUGER 10/22*

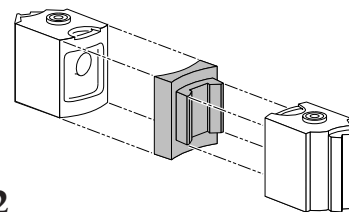

NOW CARRY 85 ROUNDS ON YOUR 10/22

* Trademark of Ruger & Co.

**QUAD-CLIP
HOLDER**

&

**DUAL-CLIP
HOLDER**

The QUAD-CLIP HOLDER and DUAL-CLIP HOLDER are designed to utilize the Ruger 10-shot rotary magazine, the most reliable magazine for the 10/22. By attaching 4 10/22 Ruger clips to the QUAD-CLIP HOLDER, the shooter has rapid access to 40 rounds of dependable firepower while still retaining the feeding reliability of the Ruger factory original magazine. An additional 44 rounds (or other items) can be stored inside the QUAD-CLIP HOLDER for a total of 84 rounds on the rifle plus 1 round in the chamber.

The DUAL-CLIP HOLDER allows ready access to 20 rounds by attaching 2 10/22 Ruger clips back-to-back.

| ORDER # | PRICE | ITEM/MODEL |
|---------|---------|---|
| 700 | \$12.95 | QUAD-CLIP HOLDER |
| 710 | \$5.95 | DUAL-CLIP HOLDER |
| 720 | \$19.95 | RUGER 10/22 10-SHOT ROTARY MAGAZINE |
| 730 | \$7.95 | BELT CARRY POUCH (Holds 1 Ruger Magazine) |

SPECIFY ORDER # AND ITEM / MODEL

ALL E&L PRODUCTS ARE UNCONDITIONALLY GUARANTEED
& MADE IN THE U.S.A.

Neither clip holder interferes with the action of the rifle or other accessories such as the activator. Both the QUAD-CLIP HOLDER and the DUAL-CLIP HOLDER are manufactured of high impact, black nylon. Ruger manufactured 10-shot rotary magazines are also available.



E & L MFG. INC.

ADJUSTABLE SLIP-ON

RECOIL PADS

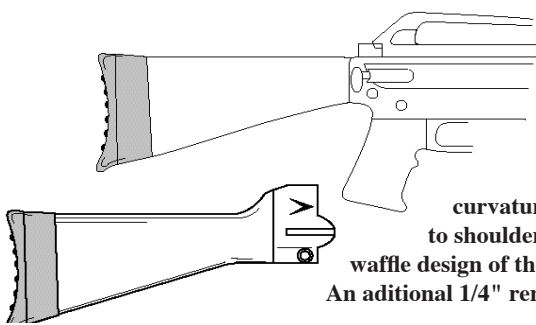

The E&L ADJUSTABLE SLIP-ON RECOIL PAD is uniquely designed to fit the curvature of your shoulder. Because of this unique design, you will discover you are now able to shoulder your weapon with improved and consistent positioning time after time. The interior waffle design of the energy absorbing pad reduces felt recoil, adding only 1/4" to the length of the stock. An additional 1/4" removable foam insert is included with each Recoil Pad if additional length is desirable.

The Small and Large Recoil Pads will fit the listed weapons and others:

SMALL RECOIL PAD

E & L STOCK EXTENSION
H&K 91/93 FIXED STOCK
H&K 94 FIXED STOCK
MINI-14, RANCH, MINI-30
RUGER 10/22 & .44 MAG. CARBINE
RUGER POLICE SERIES CARBINE
MARLIN .45 & 9mm CAMP CARBINE
FN-FAL & SAR 48
WINCHESTER 3030
BENELLI SUPER 90
H&K USC

THOMPSON 1927
SKS
WINCHESTER 69A (.22)
ALL CHOATE SIDE FOLDING STOCKS
CHOATE ECONOMY STOCKS (for
MINI-14 & 10/22)
LAW-12
SAS-12

MAK-90
REMINGTON NYLON 66
REMINGTON 1100
REMINGTON 870
REMINGTON 700
AR 180/18
ITHACA 37
MOSSBERG 500
H&K SL-6/SL-7
H&K 300

THIS IS A
PARTIAL
LISTING
ONLY
IF YOU
DON'T SEE
YOURS
LISTED
PLEASE
CALL

LARGE RECOIL PAD

AR-15/M-16 & CHOATE A2
VALMET
M14/M1A
S&W 1000
BM 59
NHM-90
M1 GARAND

CHOATE PISTOL GRIP STOCKS FOR:
REMINGTON 1100, 870 & S&W 3000
BERETTA 1200
WINCHESTER MODEL 12
FN MODEL 49
BROWNING HIGH POWER

3040 KREG
REMINGTON 721
BENELLI MONTEFELTRO SUPER 90
1903 SPRINGFIELD
ALL MUZZELITE BULPUP STOCKS
JAPANESE MODEL 99

| ORDER # | PRICE | ITEM/MODEL | DIMENSIONS |
|---|---------|---|-------------------------------|
| 550 | \$16.95 | ADJUSTABLE SLIP-ON RECOIL PAD - (SMALL) | 4-1/4" X 1-1/4" with 2" SKIRT |
| 560 | \$16.95 | ADJUSTABLE SLIP-ON RECOIL PAD - (LARGE) | 4-3/4" X 1-3/4" with 2" SKIRT |
| -- ADDITIONAL LARGE AND SMALL REMOVABLE INSERTS ARE AVAILABLE AT \$3.00 EACH -- | | | |

CLEANING BRUSHES

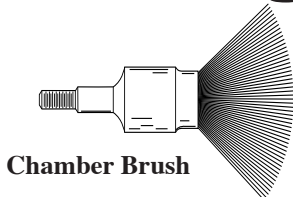

Chamber Brush



Knurled Rod



H&K 9MM Combination Bore & Flute Brush

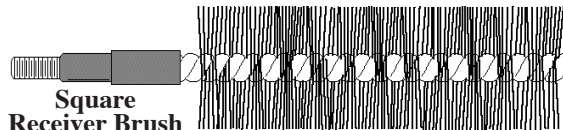

Square Receiver Brush

The E&L CHAMBER FACE CLEANING BRUSH was developed as a result of personal experience in not being able to clean the chamber face area of guns such as the H&K 91/93/94, UZI, FN-FNC, FN-FAL, MAC-10 and most other weapons. This brush has stainless steel bristles.

The square design of the RECEIVER CLEANING BRUSH will clean the entire receiver along with the magazine well. It also quickly and thoroughly cleans the inside of most large capacity magazines. This brush has stainless steel and nylon bristles.

The HK COMBINATION BRUSH was designed exclusively to clean the H&K 9MM fluted chamber and bore with one easy stroke. This brush has brass and stainless steel bristles.

The E&L KNURLED ROD does not swivel. The 15" long, 1/4" diameter ROD is knurled at one end for a comfortable hold. The ROD is designed to be used specifically with the CHAMBER FACE BRUSH, RECEIVER BRUSH and the 9MM COMBINATION BRUSH. The ROD is also ideal for general purpose cleaning when using a variety of brushes on all weapons including pistols and revolvers.

| ORDER # | PRICE | ITEM / MODEL |
|-------------------|---------|---|
| 575 | \$16.95 | CHAMBER FACE CLEANING BRUSH |
| 576 | \$16.95 | RECEIVER CLEANING BRUSH |
| 577 | \$11.95 | H&K 9MM COMBINATION BRUSH |
| 580 | \$ 8.95 | KNURLED ROD |
| 590 (Save \$4.90) | \$37.95 | SPECIAL - CONTAINS CHAMBER FACE CLEANING BRUSH, RECEIVER CLEANING BRUSH AND KNURLED ROD |
| 591 (Save \$7.85) | \$46.95 | SPECIAL - CONTAINS CHAMBER FACE CLEANING BRUSH, RECEIVER BRUSH, 9MM COMBINATION BRUSH AND KNURLED ROD |



E & L MFG. INC.

ADJUSTABLE STOCK EXTENSIONS

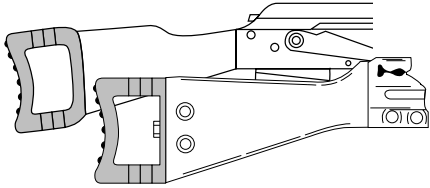

**Price - \$44.95 Each
FOR SOLID STOCKS ONLY**

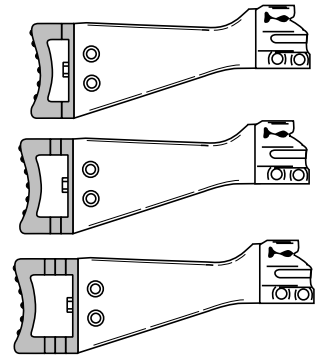
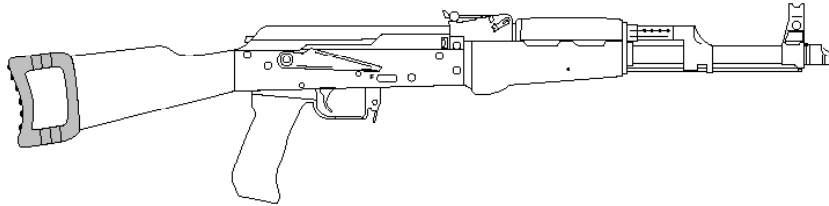

The E&L STOCK EXTENSIONS ARE ADJUSTABLE in 1/2" increments to enable you to achieve the proper length of trigger pull. The STOCK EXTENSIONS are manufactured of high impact, glass filled black nylon. Each listed STOCK EXTENSION can be adjusted to any of the 3 lengths given below.

| ORDER # | PRICE | ITEM/MODEL | ADDITIONAL LENGTH | | |
|---------|---------|------------------|-------------------|--------|--------|
| 500 | \$44.95 | HK-91/93 | 1/2" | 1" | 1 1/2" |
| 501 | 44.95 | DAEWOO M2/AR-100 | 1/2" | 1" | 1 1/2" |
| 502 | 44.95 | AK-47 | 1 3/4" | 2 1/4" | 2 3/4" |
| 503 | 44.95 | SKS | 2 1/4" | 2 3/4" | 3 1/4" |

CHEEK RESTS

The E&L CHEEK RESTS are designed to give you proper eye alignment when using a scope mounted rifle. The CHEEK RESTS are constructed of high impact, glass filled black nylon and weigh less than 3 ounces.

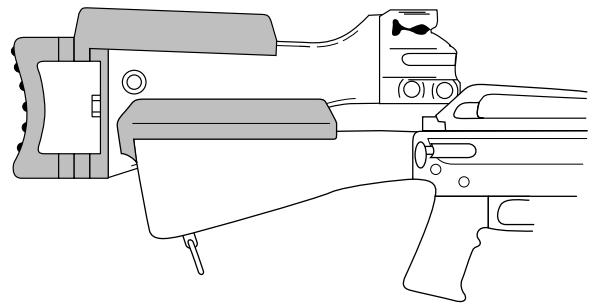

HK 91/93 CHEEK REST

The HK 91/93 CHEEK REST is designed to be used only with the E & L ADJUSTABLE STOCK EXTENSION. In addition this CHEEK REST gives you 3 choices of alignment angles - 90° which is in line with the stock, or tilted 10° left or right for optimum eye alignment and comfort.

AK-47 CHEEK REST

The AK-47 CHEEK REST is designed to be used only with the E&L ADJUSTABLE STOCK EXTENSION on solid stocks only.

AR-15/M-16 CHEEK REST

The AR-15/M-16 CHEEK REST attaches directly to either the A1, or A2 fixed stock as well as the original models without the cleaning kit compartment.

| ORDER # | PRICE | ITEM/MODEL |
|---------|---------|-----------------------|
| 525 | \$19.95 | H&K 91/93 CHEEK REST |
| 526 | \$19.95 | AR-15/M-16 CHEEK REST |
| 527 | \$19.95 | AK-47 CHEEK REST |

AMERICAN 180 • PARTS AND ACCESSORIES

E & L Manufacturing is the only source for AMERICAN 180 Parts



- American Arms International •
- Austrian Import • Illinois Arms •
- E&L Manufacturing •
- Semi-Auto's & Full-Auto's •

The Ultimate
Fun Gun

www.american180.com

THE SEMI 180'S
ARE CUSTOM
MANUFACTURED
CALL OR WRITE
FOR PRICE AND
AVAILABILITY

- BARRELS • RECEIVER TOP STRAP • BOLTS • TRIGGER ASSEMBLIES •
- FEED BLOCKS • SPRINGS • PINS • SEARS • METAL MAGAZINES •
- WINDERS • RETRACTABLE WIRE STOCK • BRIEFCASES •

WE HAVE NEW 165 / 220 / 275 ROUND MAGS

DRUMS & WINDERS WILL FIT ALL 180'S

NOW YOU CAN VISUALLY CHECK WHILE LOADING & SHOOTING

- MAGAZINE LOADING TRAY • LOADING STAND •
- BARRELS 9" 14" & 18" • CARRYING CASE • WIRE STOCK •

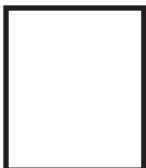

4177 Riddle By-Pass Road
Riddle OR 97469-9788
(541)874-2137 FAX (541)874-3107
www.elmfg.com www.brasscatchers.com
E-Mail elmfg@frontiernet.net

**E & L
MFG. INC.**



To

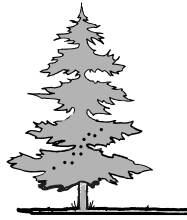

E & L MFG. INC.

4177 Riddle By-Pass Road

Riddle OR 97469-9788

541-874-2137 Fax 541-874-3107

www.elmfg.com www.brasscatchers.com www.american180.com E-Mail: elmfg@frontiernet.net

Home of the American 180 & The Best Brass Catchers In The World

ORDER FORM

SHIP TO: (Please provide complete address for U.S. Priority Mail. (For any other shipper, please specify in Customers Notes)

NAME _____ ADDRESS _____

CITY & STATE _____ ZIP _____

AREA CODE & PHONE _____

| ORDER # | ITEM/MODEL (SPECIFY FIREARM MAKE & MODEL) | QUANTITY | PRICE EACH | TOTAL |
|---------|--|----------|------------|-------|
| | | | | |
| | | | | |
| | | | | |
| | | | | |
| | | | | |
| | | | | |
| | | | | |
| | | | | |
| | | | | |
| | | | | |

Subtotal for Merchandise (from above) \$ _____

(E & L Standard Shipping Is Via. U.S. Postal Service Priority Mail)

Shipping: U.S. \$10.00 for the first \$50 from \$51 to \$100-\$12.00 (Add \$3.00 for each additional \$100.00)... \$ _____

Foreign Orders Shipping; Will be actual shipping charges. Call or e-mail for exact charges... \$ _____

Total Amount This Order \$ _____

Customer's Notes: _____

Payment Enclosed (IF CASH OR M/O)

Cardholders Name _____

Card Number _____

 Master Card

 Visa

Exp. Date _____ CVV # _____

 American Express

 Discover

Signature _____

E & L PRODUCTS ARE UNCONDITIONALLY GUARANTEED